

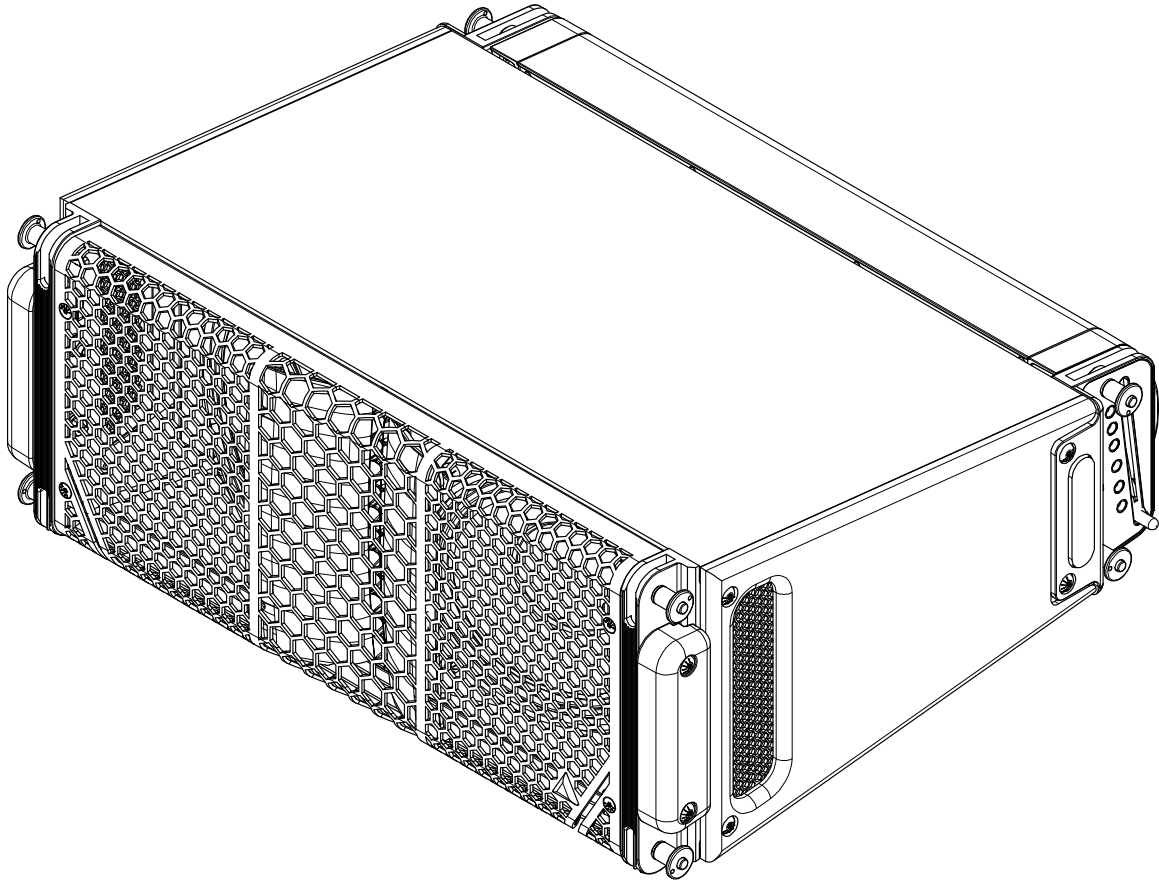

S E R I E S



USER MANUAL

Distribution Date: November 1st, 2020

CS7 User Manual

Version 1.0

Distribution Date: November 1st, 2020

Copyright © 2020 by Adamson Systems Engineering Inc.; all rights reserved.

This manual must be accessible to the person operating this product. As such, the product owner must store it in a safe place and make it available upon request to any operator.

Resale of this product must include a copy of this manual.

If this manual becomes damaged or additional copies are needed, please email support@adamsonsystems.com.

EU Declaration of Conformity

Adamson Systems Engineering declares that the products stated below are in conformance with the relevant fundamental health and safety criteria of the applicable EC Directive(s), in particular:

Directive 2014/35/EU: Low Voltage Directive

971-0005 CS7
910-0006 CS7 Amplifier Upgrade
905-0039 CS Network Distribution System
913-0003 CS Gateway
913-0005 CS Bridge
914-0002 CS Power Distribution System 110 V
914-0003 CS Power Distribution System 230 V

Directive 2006/42/EC: Machinery Directive

930-0021 Extended Beam
930-0025 Ultra-Compact Support Frame
930-0027 Ultra-Compact Micro Frame
930-0033 Moving Point Extended Beam
930-0034 Ultra-Compact Pole Mount Adaptor
932-0047 Line Array H-Clamp
932-0043 Extended Lifting Plates

Directive 2014/30/EU: Electromagnetic Compatibility Directive

971-0005 CS7
910-0006 CS7 Amplifier Upgrade
905-0039 CS Network Distribution System
913-0003 CS Gateway
913-0005 CS Bridge
914-0002 CS Power Distribution System 110 V
914-0003 CS Power Distribution System 230 V



Signed at Port Perry, ON, CA - November 1st, 2020



Brock Adamson (President & CEO)

ADAMSON SYSTEMS ENGINEERING, Inc.
1401 Scugog Line 6, Port Perry
Ontario, Canada L9L 1B2
T: +1 905 982 0520, F: +1 905 982 0609
Email: info@adamsonsystems.com
Website: www.adamsonsystems.com

Contents

Symbols	3
Safety & Warnings	4
Status LED	4
Product Overview	6
Power	7
Connectivity	9
Rack Mounted Systems	10
Control Suite	11
Technical Specifications	12

Symbols



This symbol alerts the user that there are important operating and maintenance instructions in the literature accompanying this appliance



This symbol alerts the user to the presence of voltages that can cause dangerous electric shock



This symbol alerts the user to the weight of the appliance that can cause muscle strain or back injury



This symbol alerts the user that the appliance can be hot to the touch and should not be touched without taking care and instruction

Safety & Warnings



Read these instructions and keep them available for future reference.

This manual can be downloaded from
<https://adamsonsystems.com/en/support/downloads-directory/cs-series/cs7>.

Heed all warnings and follow all instructions.

Clean this product with a dry cloth only.

Never restrict the ventilation ports.

Protect the cabling from being walked on or pinched.



A qualified technician must be present during the installation and use of this product. This product is capable of producing extremely high sound pressure levels and should be used according to the specified local sound level regulations and good judgement. Adamson Systems Engineering will not be liable for damages caused by any possible misuse of this product.



Inspect the product before each use. If any sign of defect or damage is detected, immediately withdraw the product from use for maintenance.



Servicing is required when the loudspeaker has been dropped or damaged in any way or does not operate normally. All service requirements must only be undertaken by a trained service technician.



View the CS-Series Rigging Tutorial video and/or read the CS-Series Line Array Rigging Manual before suspending the CS7. Rigging information and safety warnings presented in Adamson CS must be strictly adhered to. Use only with the rigging frames/accessories specified by Adamson or sold with the loudspeaker system.

This speaker enclosure is capable of creating a strong magnetic field. Please use caution around the enclosure with data storage devices such as hard drives.



This product contains potentially dangerous voltages.

Do not open the unit. There are no user serviceable parts inside this product. Failure to comply voids warranty.

Do not use this product with a power cable that does not have a polarized, grounded plug.

Do not install this product in wet or humid locations.

Unplug this product from the power source during lightning storms.

Safety & Warnings



Avoid lifting this product. For movement and storage, use only the cart or case sold by Adamson for the product, or one as specified by Adamson. Be sure to use caution while moving the case or cart to avoid injury.



This product can get hot when in use for extended periods of time.

To reduce the risk of overheating the product, avoid exposing it to direct sunlight.

Do not install this product near heat sources such as radiators, heat registers, stoves, or other apparatus that produce heat.

Status LED



	Colour	State
Start-Up	Green	Flashing
Normal Operation	Green	Solid
Amplifier Off	Amber	Solid
Amplifier Clipping	Red	Flashing
General Fault	Red	Solid

In an effort to continuously improve its products, Adamson releases updated software, presets and standards for its products.

Adamson reserves the right to change the specifications of its products and the content of its documents with no prior notice.

Product Overview

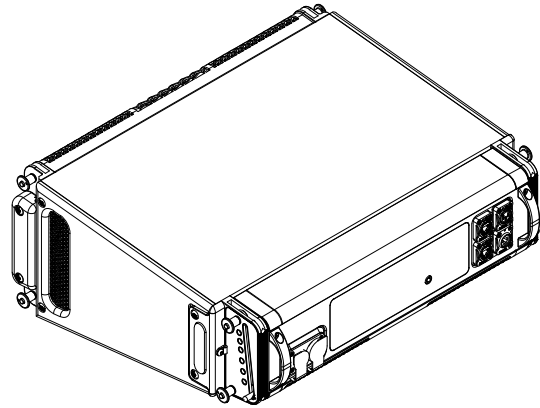
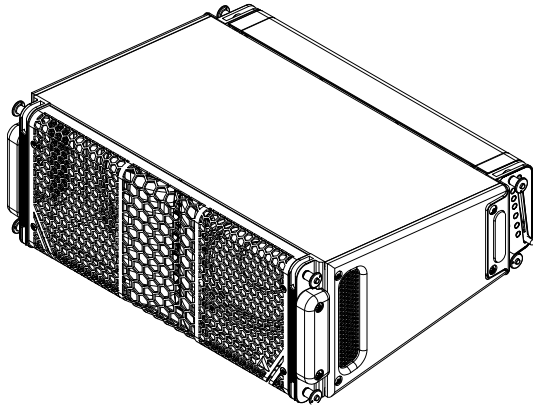

The CS7 is an ultra-compact, powered, intelligent, line array enclosure designed for medium throw applications. It contains two symmetrically arrayed 7" LF transducers, and a 3" HF compression driver mounted onto an Adamson waveguide. The high frequency waveguide is designed to couple multiple cabinets across the entire intended frequency band without loss of coherence.

Each CS7 cabinet houses proprietary Class-D Amplification and comprehensive internal signal processing including Milan-ready AVB connectivity. Internal switch fabric allows multiple enclosures to be daisy-chained in order to reduce the required amount of cabling in complex system setups.

The operational frequency range of the CS7 is 80Hz to 18kHz. The use of proprietary technologies such as Controlled Summation Technology and Advanced Cone Architecture allow high maximum SPL and maintains a consistent nominal horizontal dispersion pattern of 100° down to 400Hz.

The enclosure is made of marine grade birch plywood, with an integrated aluminum and steel four-point rigging system. Without sacrificing low resonance to composite material, the CS7 weighs only 17.5 kg / 38.6 lbs.

Up to sixteen CS7 can be flown in the same array when using the Ultra-Compact Support Frame (930-0025) and up to eight when using the Ultra-Compact Micro Frame (930-0027). Nine rigging positions are available, allowing vertical inter-cabinet splay angles from 0° to 12.5°. Always consult Adamson CS Software and the CS-Series Line Array Rigging Manual for correct rigging positions and proper rigging instructions.

The CS7 is intended to be used as a standalone system or with other CS-Series products and is designed to pair easily and coherently with all CS-Series subwoofers.

Power



The CS7 utilizes advanced loudspeaker technology, augmented with advanced power processing. Understanding electrical safety is critical in the safe operation of this product.



This product must always be grounded/earthed. Do not ground-lift the AC cable - never use a ground-lifting adapter or cut the AC cable ground pin.



Improper grounding of connections between loudspeakers and the rest of the audio system may produce noise or hum and can damage the input and output stages of the system's electronics components.

Before applying AC power to the loudspeaker, make sure that the voltage potential difference between the neutral and earth/ground lines is less than 5 V AC when using single-phase AC wiring.

The CS7 is equipped with one Neutrik powerCON TRUE1 20 A locking input connector and one Neutrik powerCON TRUE1 20 A locking output connector on the CS7.

The accepted voltage range is 100 V - 240 V AC.

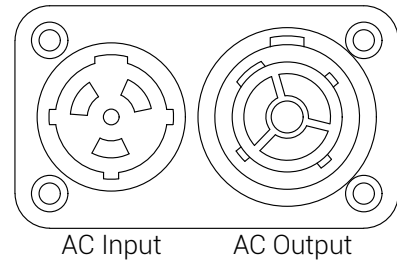

The line-to-ground voltage should never exceed 250 V AC. The CS7 is protected against excessive voltages but will need to be serviced should that protection be engaged.

The input voltage supplied to the AC Input connector will be the same voltage supplied to any additional CS-Series products connected to the CS7's AC Output connector. The number of loudspeakers that is safe to link in this manner is determined by the supply voltage, the total current draw of all connected loudspeakers on the circuit, the circuit breaker rating, and the rating of the utilized AC cabling.

When linking AC power for additional CS-Series products, do not exceed the current capability of the AC Input connector. Consider the total current draw for all loudspeakers on the circuit, including the first.



For long periods of idle it is recommended to switch amplifiers to standby (requires Adamson CS software) to reduce cooling fan run-time.

Power

	100 V	115V	120 V	208 V	230 V	240 V
RMS Long-Term	3.45 A	3.00 A	2.88 A	1.66 A	1.50 A	1.44 A
RMS Idle	1.04 A	0.90 A	0.86 A	0.50 A	0.45 A	0.43 A
Peak	20.70 A	18.00 A	17.25 A	9.95 A	9.00 A	8.63 A

Table 1 - Single cabinet current draw



Current draw for the CS7 is dynamic and fluctuates as operating levels change.

The **CS Power Distribution System (PDS, 914-0002 - 110 V/914-0003 - 230 V)** provides six individually protected AC circuits of 208/230 V, 16 A. **When using the Adamson PDS, you can link a maximum of six CS7 loudspeakers per circuit.**

When wiring an AC cable for use with this product in a single-line system, use the wiring scheme described below in Table 2 and illustrated with Fig. 1. All work must be completed by a qualified technician.



Fig. 1

Hot or Live (L)	Brown
Neutral (N)	Blue
Protective Earth / Ground (E or PE)	Green and Yellow

Table 2

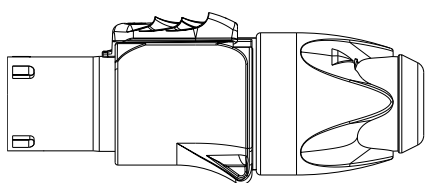

powerCON True1 AC Cable Input Connector

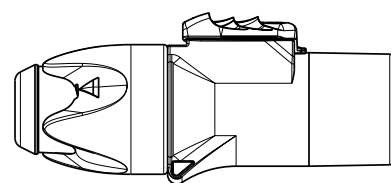
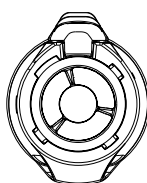

powerCON True1 AC Cable Output Connector

Connectivity

On-board Digital Signal Processing (DSP) is accessed via two data ports on the rear of the cabinet. These ports are used to stream AVB audio as well as transmit AES70 control data. All CS-Series loudspeakers are configured to receive two separate LAN signals on a single data link. The **CS Network Distribution System (NDS, 905-0039)** combines both LANs on one ethernet cable. This approach allows network redundancy as well as the ability to daisy-chain control data and digital audio between enclosures.

When using the NDS, up to six CS-Series loudspeakers can be daisy-chained on a single network path. This quantity takes into account the CS Gateway, the CS NDS, the network switches, as well as each CS loudspeaker to determine the amount of latency created by each individual hop, and ensuring the total latency remains within pre-determined parameters. The audio signal latency between each CS7 is 0.26 ms, jump to jump.

All CS-Series cabinets are Milan-ready. With Milan, every device will automatically connect with any other Milan device using a variety of standard formats and definitions in the protocol.

Each CS-Series loudspeaker is equipped with balanced XLR input and output connectors for line level analog audio signals.

The CS7's drivers are powered by a proprietary two-channel class D amplifier capable of providing up to 2400 W of combined output power.

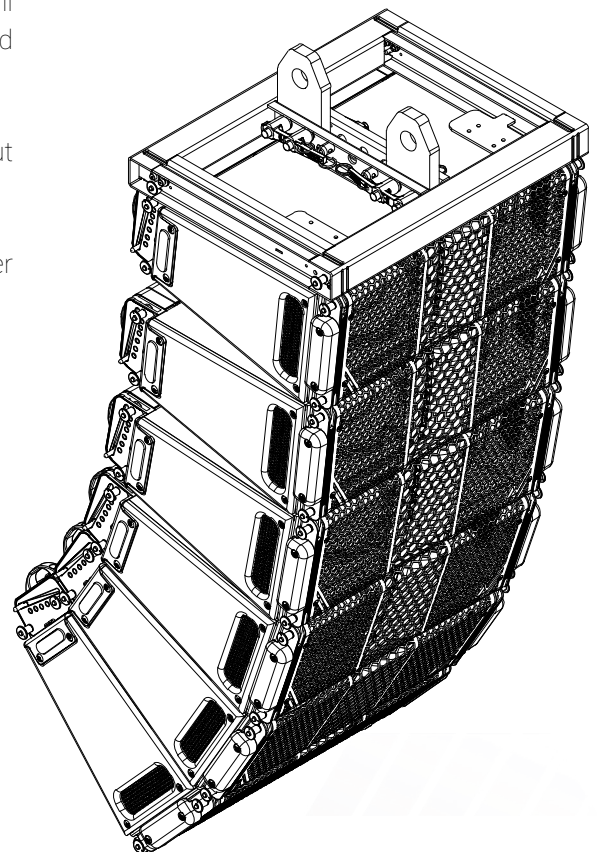
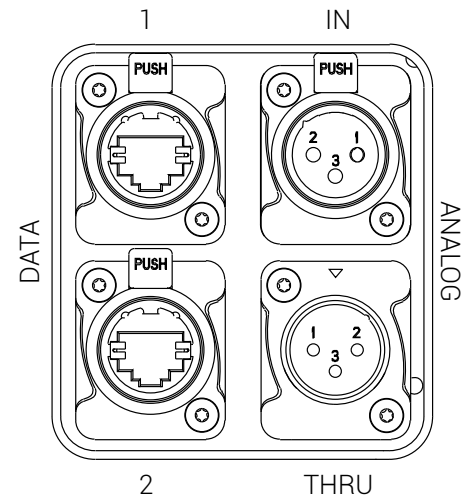

Rack Mounted Systems

CS Gateway (913-0003) - The AVB on-ramp into the CS-Series ecosystem, the CS Gateway is a 16x16 matrix with 16 channels of user accessible DSP, containing dual-LAN, Milan-ready AVB, AES/EBU, and analog connections. The Gateway converts AVB to and from analog and AES/EBU. An extremely powerful tool, the Gateway's network connectivity also allows for integrating other systems link broadcast feeds or matrixing multiple consoles in a festival environment.

CS Bridge (913-0005) - The CS Bridge is designed to replace existing network infrastructure in Adamson's E-Rack, allowing users to seamlessly integrate the CS-Series into their existing inventories by converting dual-LAN, Milan-ready AVB signal to AES/EBU for networking to existing Lab.gruppen amplifiers, while also offering six channels of DSP per unit.

CS Network Distribution System NDS (905-0039) - The NDS is a network and analog patch bay that allows users to send redundant audio and control to CS-Series loudspeakers on a single network cable. The NDS combines LAN A and B network ports with 2 AVB switches.

CS Power Distribution System PDS (914-0002/914-0003) - Available in 110 V (2x L21-30) and 230 V (32 A CEE) models, the PDS is designed to ensure that all CS-Series system components receive ample power. The PDS provides six circuits of 208 V or 230 V, 16 A offered via powerCON or Socapex outputs. An integrated data port allows users to monitor consumption data, both per power output and for overall draw.

CS Gateway Front

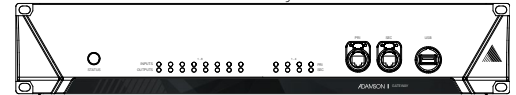

CS Gateway Back

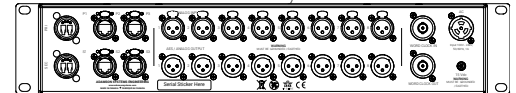

CS Bridge Front



CS Bridge Back

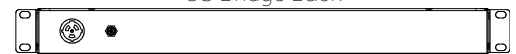

CS NDS Front



CS NDS Back



CS PDS Front

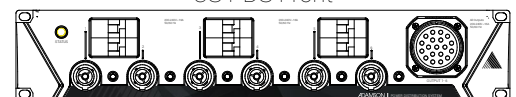

CS PDS Back

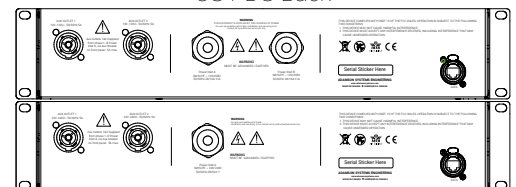

Control Suite

Adamson CS is a single software platform which allows the user to design and deploy a system, all from a single interface. From room design and simulation to connectivity and diagnostics, this unified platform reduces the need for additional software in order to properly deploy and deliver complete audio systems.

Design - Using basic geometric shapes, users are capable of designing a space, from a basic field, to a complex structure. When arena or stadium design is needed, multi-point Extrude and Revolve surfaces will easily allow you to set multiple inclines and elevated surfaces with a few keystrokes.



Simulation - After placing virtual cabinets in your room design, different aspects of their behaviour may be simulated, including 2D and 3D SPL, delta time of two cabinets, and speaker directivity.

Patch - Quickly and effectively assign virtual loudspeakers to their real-world counterparts, then determine control zoning and AVB routing to ensure complete control over your environment.

Optimization - With DSP in every cabinet, you have more control than ever over your system. Adamson's proprietary Optimization algorithm gives you incredible control over the listening experience, taking advantage of each line array element's on-board DSP to deliver accurate, uniform sound.

Control - Gain, Muting, Delay, EQ, and Grouping are all controlled on a single page, allowing you to build and fine-tune your system with as little friction as possible. Implement your changes on a per-box level or use control zones to shape the performance of multiple cabinet groupings.

Metering - Access input and output metering for all online devices on one page, so you can reliably determine headroom for your entire system.

Diagnose - Monitor your system with a comprehensive set of system insight tools including spectral impedance and displacement, inclinometer monitoring, clip and limiter tracking, power consumption, and AVB stream statistics.



For more information, see the Adamson CS User Manual.

Technical Specifications

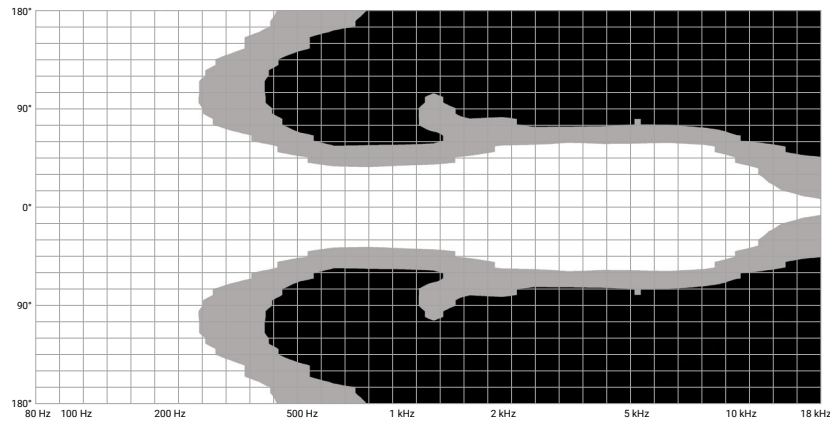

CS7 Horizontal Pattern

Frequency Range (-6 dB)	80 Hz - 18 kHz
Nominal Directivity (-6 dB) H x V	100° x 12.5°
Maximum Peak SPL**	138 dB
Components LF	2x ND7-LM16 7" Kevlar Neodymium Driver
Components HF	NH3 3" Diaphragm / 1.4" Exit Compression Driver
Rigging	Slidlock Rigging System
Connections	Power: powerCON TRUE1 Network: 2x etherCON Analog: 2x XLR
Width (mm / in)	527 / 20.75
Height Front (mm / in)	203 / 8
Height Rear (mm / in)	122 / 4.8
Depth (mm / in)	411 / 16.2
Weight (kg / lbs)	17.5 / 38.6
Amplification	Two channel Class-D, 2400 W total output
Input Voltage	100 V - 240 V
Current Draw at 230 V	0.45 A rms idle, 1.5 A rms long-term, 9 A max peak
Processing	Onboard / Proprietary

12 dB crest factor pink noise at 1m, free field, using specified processing and amplification

